

# A home built heat treatment furnace

## WARNING NOTICE

***Anyone following these instructions does so at their own risk.  
All electrical installations should be inspected and tested by a qualified electrician.***

***You are working with high voltages and temperatures.***

The following instructions describe the design and construction of a simple but effective heat treatment furnace suitable for the knife maker.

All measurements for the body of the furnace are given as a guide only, you are free to make yours as large as you want but making it smaller will cause problems in installing your elements. The casing measures ( 310mm wide x 270mm high x 465mm deep ) and the internal chamber measures ( 145mm wide x 110mm high x 380mm deep ) this is suitable for most sizes of knife blade unless you're intending making very large Bowie or camp/field type knives.

### Furnace body

First of all you will need a minimum of 24 firebricks, these are the lightweight type 23 insulation bricks. Don't be tempted to use any of the hard, heavy firebricks as these don't insulate and you will not be able to carve the grooves for the elements.

Next if you are building to the same size as I have, you will need to get some 20 gauge stainless or mild steel sheet. I suggest that you have this cut

by guillotine at your steel suppliers, as you need it to be perfectly square.

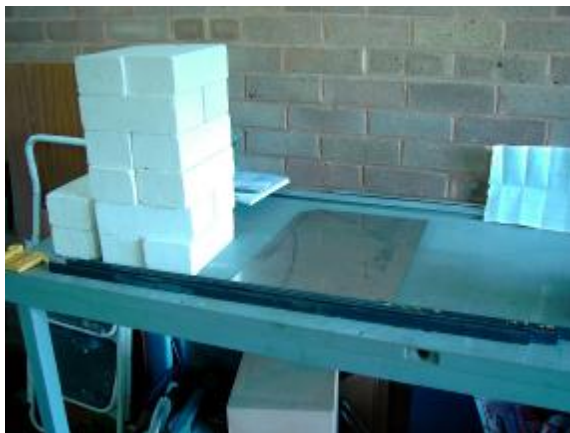

300mm wide x 460mm long x 2 off for top and bottom of case.

260mm wide x 460mm long x 2 off for each side.

300mm wide x 260mm high x 2 off for end and front door.

You will then need approx 5.4 m of 25mm x 25mm x 3mm thick angle

iron.

Lots of 5mm pop rivets!!!!

I will not go into too much detail on how to build a box from angle and steel sheet as I am sure most of you are capable of working it out for yourself from the following photo's. needless to say, you are constructing a box on legs with dimensions as shown in paragraph 2. Just remember that you will have to be able to remove the top to install the elements and firebricks.





Fit your firebricks in the case, working from the centre outwards and then cutting the bricks to fit. You should end up having to cut bricks about 35mm wide on either side. The brick are VERY easy to cut with an ordinary handsaw used for wood. I have also used a hacksaw blade for trimming and carving the grooves.



Once you have got to the stage as shown in the last photo, number the top layer of bricks so that you get them back in the same order.

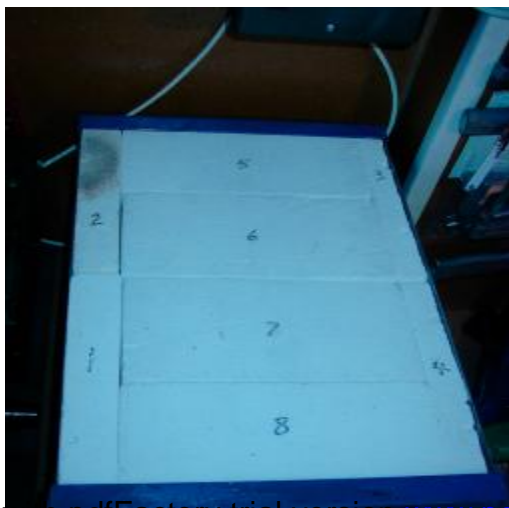

### Cutting element grooves and fitting elements

You will need to cut four equally spaced grooves down each side to hold your elements. These should be a snug fit around the element and be cut at a slight inwards angle as in this photo. This can be achieved by cutting two parallel cuts with the handsaw and the break out the middle. I then shaped the bottom of the groove with a hacksaw blade. Then finally to get a round bottom to the groove I took the element and rubbed it along the groove to finish it of.



The elements MUST be made from Kanthal wire and are rated at 13 amp, 3.1KW 240V. If you use the same supplier as me you will need two elements wired in series.

Each element is .270 in.O.D. x 34 in. long. Each element MUST be stretched to a minimum of 60 inches, and should not be stretched more than about 140 inches. They are designed to work at a maximum temperature of 2300 oF.

For more details on the elements please visit Budget Casting Supplies.

[www.budgetcastingsupply.com](http://www.budgetcastingsupply.com)

This is an American company that are really helpful and don't mind dealing with small orders for hobby users. I ordered and paid for my elements and



control by Paypal [www.paypal.com](http://www.paypal.com) They were very quick in getting the order out and Paul at BCS got back to my emails within hours!!!

After stretching the elements you will have to coax them into laying into the grooves. The ends of the groove will need rounding round to allow a smooth change in direction.



If the elements want to jump out of the grooves you can push small pins bent in the shape of hair pins or horse shoes! Around the element and into the firebrick. This is why you need the soft bricks!!!!

The two elements are joined with a 6mm stainless nut and bolt and the two ends are taken through the back wall of the furnace firebricks with two more 6mm x 100mm stainless steel bolts. You must ensure that the bolts DO NOT come in contact with the furnace case or you will get a VERY dangerous shorting out of the elements and the case will be LIVE!!!! I made the holes in the back wall about 25mm dia and made sure the bolts were well clear of any metal work. Also to give the bolts something to tighten against, I passed both bolts through a piece of Tuffnol insulation board.

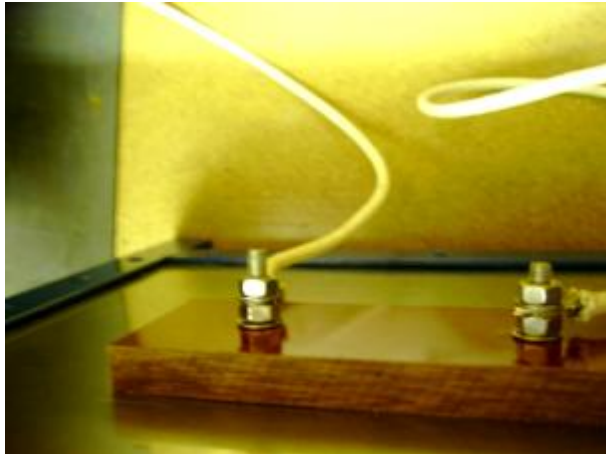

The wires from the element bolts to the control should be high temperature insulated wire used specifically in wiring of furnaces and kilns. The above connections should be covered by an insulated cover before use.

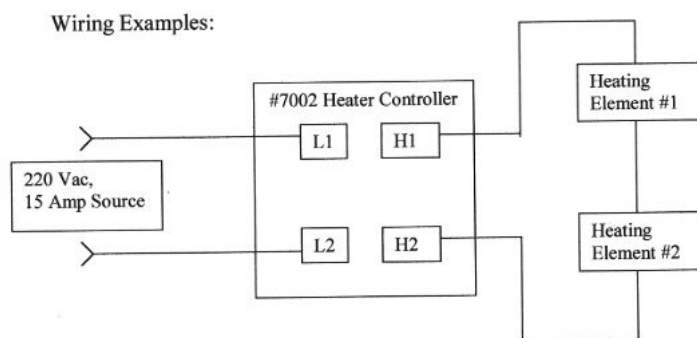

The above diagram shows the wiring for an infinite heat control. More details on this control can be found on the BCS site.

[www.budgetcastingsupply.com/Heating\\_Elements\\_Controllers.html](http://www.budgetcastingsupply.com/Heating_Elements_Controllers.html)

BCS also will supply a detailed sheet with the elements, which contains lots of useful information on installing and looking after your elements.

This is the same type of control you would have on a domestic oven. You will need some other method of measuring the temperature with a K type thermocouple. You can get reasonably priced digital multimeters with K

type thermocouple connections but make sure the meter will measure up to at least 1100 oC if you intend heat treating stainless steel.

You can also use a programmable control and thermocouple that will not only read temperature but will maintain a set temperature or ramp up and down as required.

### Front door

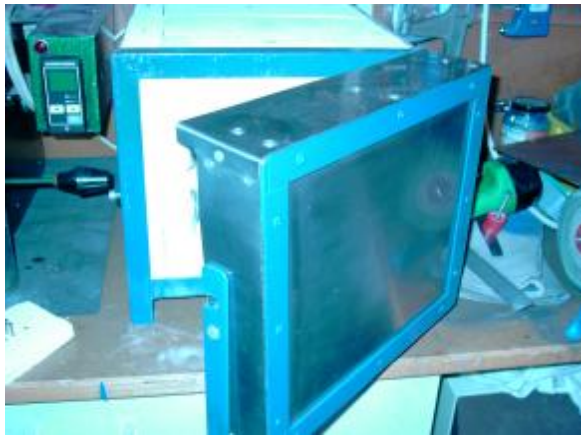

The front door is yet again constructed from 25mm x25mm angle iron and stainless sheet. The overall thickness is about 50mm. You will have to construct it in such a way as you can remove to top of the door in slide the firebricks into place. I have made by door top about 15mm wider so that it laps over the top of the furnace. This not only helps with the seal but also helps support the weight of the door when closed. I have fixed 25mm wide asbestos substitute tape to the face of the door to form a seal. The better the seal on your furnace door the faster you will be able to reach your desired temperatures and also prevent fluctuation in temperatures. The door is mounted on simple metal hinges riveted to the door and furnace side. The latch was made as simple as possible and holds the door on the seal.

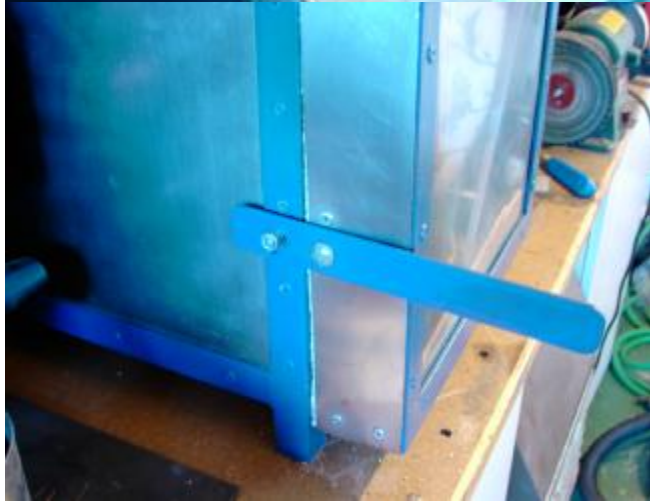
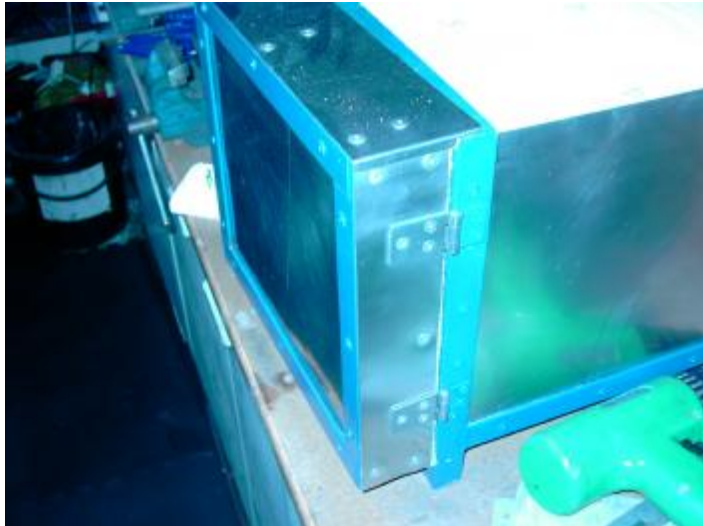



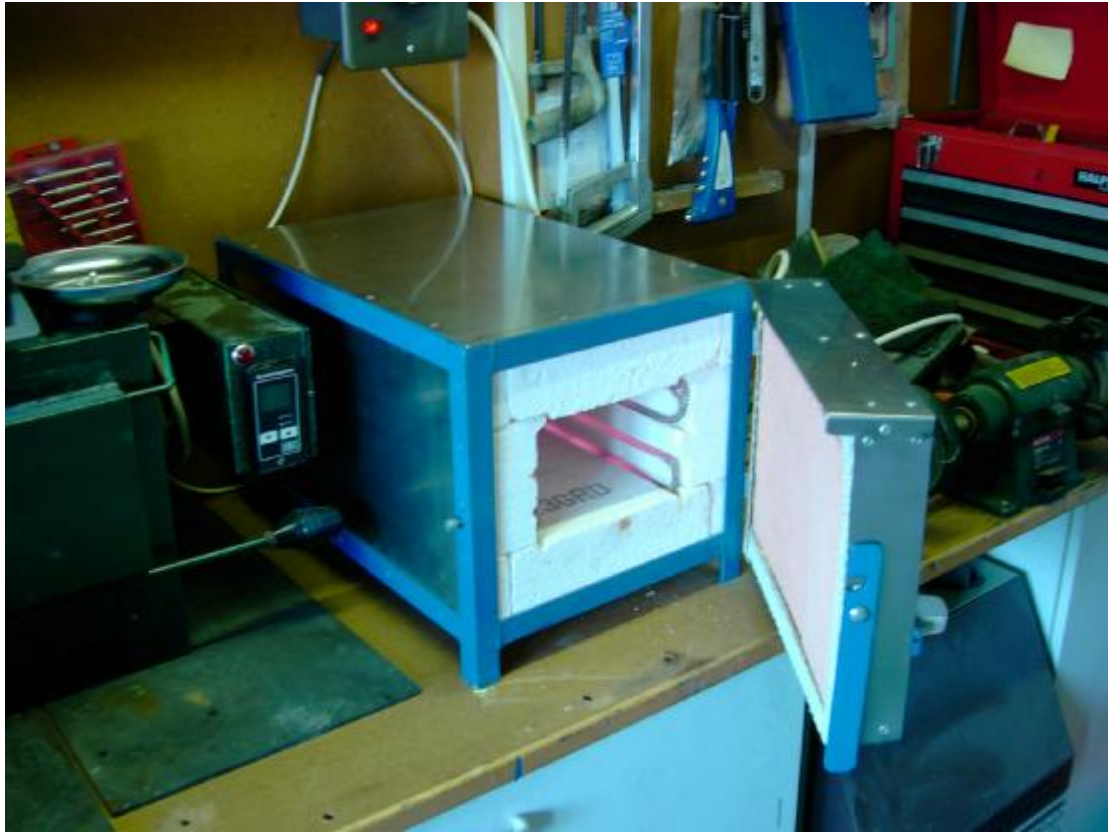

I hope this document has been of some interest and will inspire you to have a go at making a Heat Treatment Furnace of your own. If you need any more information please email me at <mailto:andy@apgascoigne.co.uk> remove the (nospam) from email